

# INSTALLATION INSTRUCTIONS FOR 4 ROLL VERTICAL PAPERGUARD IN SATELLITE® TUFWAY, MAXIM 2000, MAXIM 3000 AND SYNERGY® HIGH TECH 1, AND HIGH TECH II, AND TAURUS

**TOOLS:** •Elec / cordless drill •Rivet gun •Drill bit # 10 •Marker

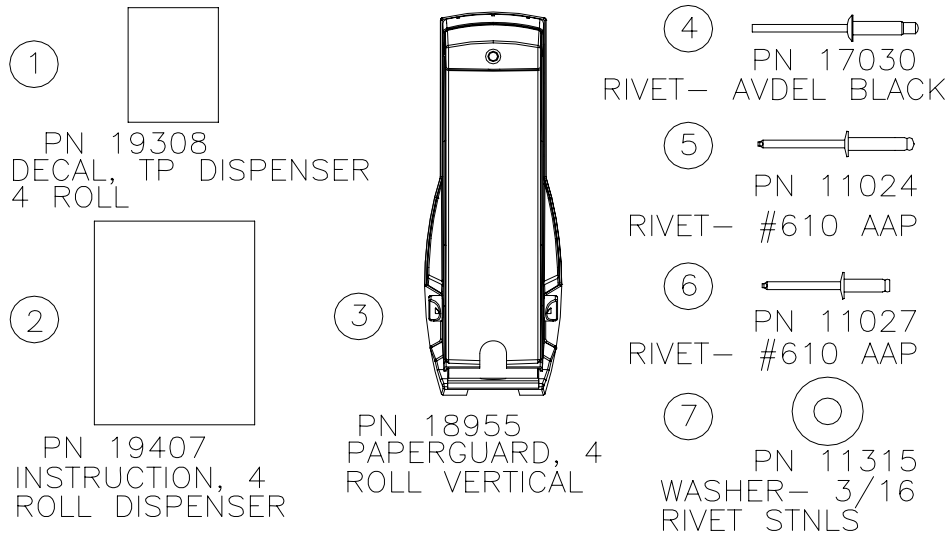

## Helpful hints:

- \*All paperguards on single wall units are fastened with the rivets being installed from the outside and the washers on the inside of the toilet.
- \*Check to see if your toilet is getting a Handwash first, so you don't drill holes in the wrong location.
- \*On the double wall toilets (High Tech and Maxim 3000) drill through the first layer only.

## \*Location of first mounting hole for toilets.



### SINGLE WALL UNITS

#### Taurus

1. Mounting location without slimmate. Mark inside right panel near front. 3-3/4" down from bottom of logo area and 4-1/4" over from molded feature in panel. Then drill hole using #10 drill bit	2. Mounting location with slimmate. Mark inside right panel near middle. 11" up from bottom of logo area and 17-3/4" over from right edge of logo area in panel. Then drill hole using #10 drill bit.	3. Location without slimmate	4. Location with slimmate

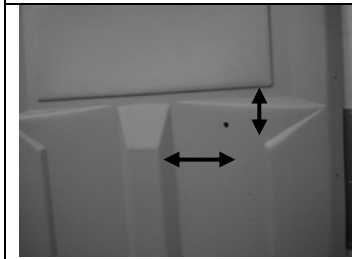
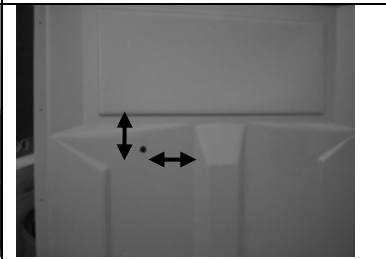

Fasten the 4 roll paperguard to panel using #11027 (3) Rivet, #66 alum and #11315 (3) Washer, 3/16 stnls. Fasten paperguard on the inside with washer and rivet from the outside of the toilet. Using the top hole on the inside of paperguard and Transfer drill bottom two holes (one on each side) through paperguard and fasten to panel.

## TUFWAY

<p>1. Mounting location without slimmate. Mark inside right panel near front. 3-3/4" down from bottom of logo area and 6-5/8" over from molded feature in center panel. Then drill hole using #10 drill bit</p>	<p>2. Mounting location with slimmate. Mark inside rear panel. 3-3/4" down from bottom of logo area and 6-5/8" over from left edge of molded feature in panel. Then drill hole using #10 drill bit</p>	<p>3. Location without slimmate</p>	<p>4. Location with slimmate</p>
			

Fasten the 4 roll paperguard to panel using #11027 (3) Rivet, #66 alum and #11315 (3) Washer, 3/16 stnls. Fasten paperguard on the inside with washer and rivet from the outside of the toilet. Using the top hole on the inside of paperguard and Transfer drill bottom two holes (one on each side) through paperguard and fasten to panel.

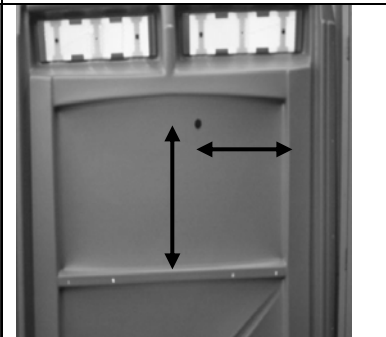



## Maxim 2000

<p>1. Mounting location without slimmate. Mark inside right panel near front. 3-1/4" up from bottom of logo area and 4-1/4" over from left edge of logo area. Then drill hole using #10 drill bit</p>	<p>2. Mounting location with slimmate. Mark inside left panel near rear. 14" up from bottom of logo area and 17-3/8" over from left edge of logo area. Then drill hole using #10 drill bit</p>	<p>3. Location without slimmate</p>	<p>4. Location with slimmate</p>
			

Fasten the 4 roll paperguard to panel using #11027 (1) Rivet, #66 alum and #11315 (3) Washer, 3/16 stnls. Fasten paperguard on the inside with washer and rivet from the outside of the toilet. Using the top hole on the inside of paperguard and Transfer drill bottom two holes (one on each side) through paperguard and fasten to panel using #11024 (2) Rivet, #610 AAP on bottom two holes.

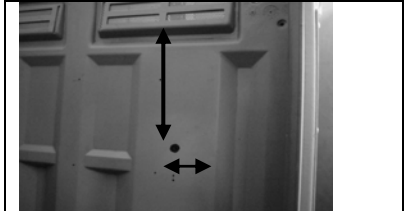

## DOUBLE WALL UNITS

### High Tech (Caution: Do not drill through outside wall of panel)

1. Mounting location without slimmate. Mark inside right panel near front. 11-1/4" down from bottom of screen area and 3-5/8" over from molded feature in panel. Then drill hole using #10 drill bit	2. Mounting location with slimmate. Mark inside right panel near middle. 11-1/4" down from bottom of screen area and 3-5/8" over from molded feature in panel. Then drill hole using #10 drill bit.	3. Location without slimmate	4. Location with slimmate
			



Fasten the 4 roll paperguard to panel using #17030 (3) Rivet, avdel black. Fasten paperguard on the inside of the toilet. Using the top hole on the inside of paperguard and Transfer drill bottom two holes (one on each side) through paperguard and fasten to panel. Note: Be careful just to drill through first layer only.

### High Tech II

1. Drill out (3) dimples located on inside, right front corner of unit [about 1/2 the way up from the base on right door frame right side panel] using a # 10 Drill bit " <b>be careful not to drill through outside wall of front / panel</b> ".	2. Secure 4 roll toilet paper holder P/N 18955 to front / panel using rivet Avdel silver P/N 17436 (1) on inside at top of dispenser [toilet paper holder lid needs to be open].	3. Secure 4 roll toilet paper holder P/N 18955 to front / panel using rivet Avdel silver P/N 17436 (2 total, one per side) on outside near bottom of dispenser.
		

Fasten the 4 roll paperguard to panel using #17030 (3) Rivet, avdel black. Fasten paperguard on the inside of the toilet. Using the top hole on the inside of paperguard and Transfer drill bottom two holes (one on each side) through paperguard and fasten to panel. Note: Be careful just to drill through first layer only.

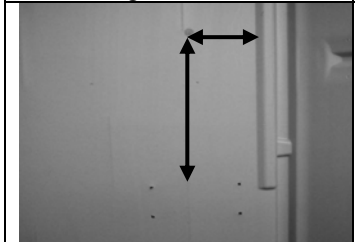
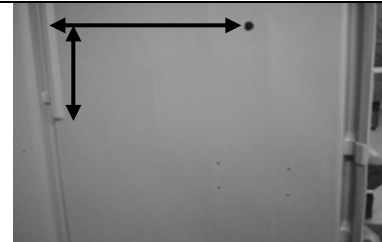
### Maxim 3000

1. Mounting location without slimmate. Mark inside right panel near front. 15" up from top two dimples for mounting paperguard and 5" over from molded feature in center panel. Then drill hole using #10 drill bit	2. Mounting location with slimmate. Mark inside left panel near rear. 15" up from top two dimples for mounting paperguard and 21-1/2" over from molded feature near front of panel. Then drill hole using #10 drill bit	3. Location without slimmate	4. Location with slimmate
			

Fasten the 4 roll paperguard to panel using #17030 (3) Rivet, avdel black. Fasten paperguard on the inside of the toilet. Using the top hole on the inside of paperguard and Transfer drill bottom two holes (one on each side) through paperguard and fasten to panel. Note: Be careful just to drill through first layer only.